

Ante sp. 22 mm con 4 lati bordo dritto per mobili con maniglia esterna, push-pull e gola curva

22mm thick doors, for units with external handle, push-pull or curved groove profile
 Portes ép. 22 mm avec 4 cotés chant droit pour meubles avec poignée externe, push-pull et gorge creuse
 Puertas gr. 22 mm con 4 lados canto recto para muebles con tirador exterior, push-pull y gola curva

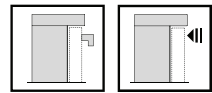

SENZA GOLA
 WITHOUT GROOVE
 SANS GORGE
 SIN GOLA

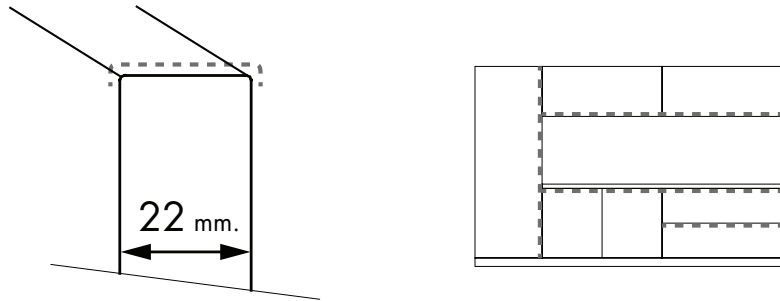
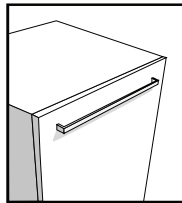

Maniglie esterne (Incluse nel prezzo):
 Protruding handles included in the price
 Poignées externes inclus dans le prix
 Tiradores exteriores incluidos en el precio

Vedi pag. 451
 See page 451
 Voir page 451
 Ver pag. 451

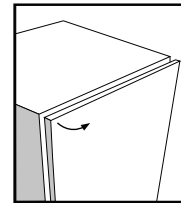

Push-pull per anta battente (Incluso nel prezzo)

Push-pull for hinged door (included in the price)
 Push pull pour porte battente (inclue dans le prix)
 Push-pull para puerta batiente (incluido en el precio)

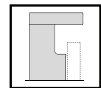

GOLA CURVA
 CURVED GRIP GROOVE
 GORGE CREUSE
 GOLA CURVA

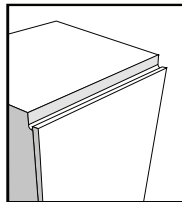

Finiture gola standard:
 Standard groove finishes
 Finitions gorge standard:
 Acabados gola estandard



Altre finiture disponibili:
 For more finishes:
 Autres finitions disponibles:
 Otros acabados disponibles:

Rivestite: Rovere spazzolato - Melaminico / Laccate: Sand - Lucido - Soft-touch - Metal - Ossidato
 Coated: Rovere spazzolato - Melaminico / Laccate: Sand - Lucido - Soft-touch - Metal - Ossidato
 Recouvert: Chêne brossé-melaminé / laqué sand - brillant - soft touch - Metal - Oxydé
 Forrado: Rovere spazzolato - Melaminico / Laccate: Sand - Lucido - Soft-touch - Metal - Ossidato

FINITURE

FINISHES - FINITIONS - ACABADOS

Fascia prezzo
 Price range
 Gamme de prix
 Grupo de precio

MELAMINICO TERMOSTRUTTURATO

MELAMINE THERMOFRAMED - MÉLAMINE THERMOSTRUCTURED - MELAMINICO TERMOESTRUCTURADO

Poro registro

Poro registro
 Poro registro
 Poro registro



Sabbiato

Sabbiato
 Sablé
 Sabbiato



Materico

Materico
 Textured
 Matériel
 Materico



Texture

Texture
 Texture
 Texture

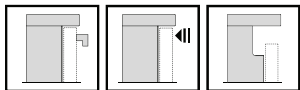

**MELAMINICO SUPERMATT**

SUPERMATT MELAMINE - MÉLAMINE SUPERMATT - MELAMINICO SUPERMATT

1



bianco laser

avorio

creta

shadow

grigio segnale

grigio ferro

TECNOLUX

TECNOLUX - TECNOLUX - TECNOLUX

1-2



bianco

vaniglia

gianduia

fumo

TECNOMATT

TECNOMATT - TECNOMATT - TECNOMATT



bianco matt

office matt

gianduia matt

fumo matt

FENIX NTM

FENIX NTM - FENIX NTM - FENIX NTM

3



bianco kos

grigio Londra

nero ingo

FENIX NTM JTIME

FENIX NTM JTIME - FENIX NTM JTIME - FENIX NTM JTIME

5



Bianco Malè

beige arizona

castoro ottawa

grigio efeso

grigio antrim

grigio bromo

verde comodore

piombo doha

titanio doha

bronzo doha

FENIX NTA

FENIX NTA - FENIX NTA - FENIX NTA

8

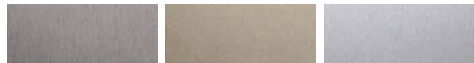

hamilton nta

oro cortez nta

argento dukat nta

LAMINATO HPL

LAMINATE HPL - LAMINE HPL - LAMINADO HPL

4

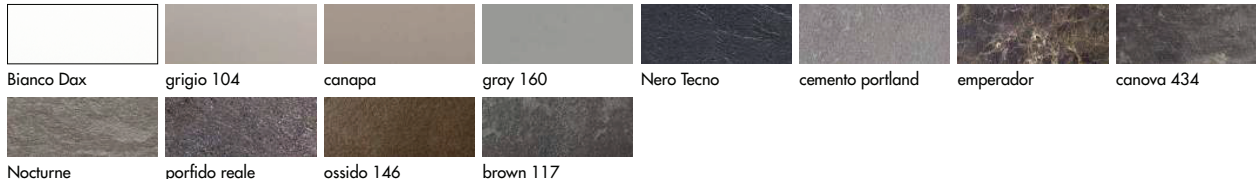

Bianco Dax

grigio 104

canapa

gray 160

Nero Tecno

cemento portland

emperador

canova 434

Nocturne

porfido reale

ossido 146

brown 117

LACCATI

LACQUERED - LAQUES - LACADOS

3

sand / sand / Sand / sand

4

lucido / Glossy / Brillant / Brillo

5

soft-touch / soft-touch / Soft touch / soft-touch

8

ossidato / oxidato / oxidato / oxidato

9

metal / Metal / metal / metal

Tutte le finiture laccate sono consultabili nella sezione "K_Colors by Arrital" pag. 39
 All the lacquered finishes can be checked in the section "K_Colors by Arrital" at page 39
 Toutes les finitions laquées sont disponibles dans le chapitre "K_Colors by Arrital" pag. 39
 Todos los acabados pueden ser consultados en la sección "K_Colors by Arrital" en la página 39

ROVERE SPAZZOLATO

ROVERE SPAZZOLATO - CHENE BROSSE - ROVERE SPAZZOLATO

5

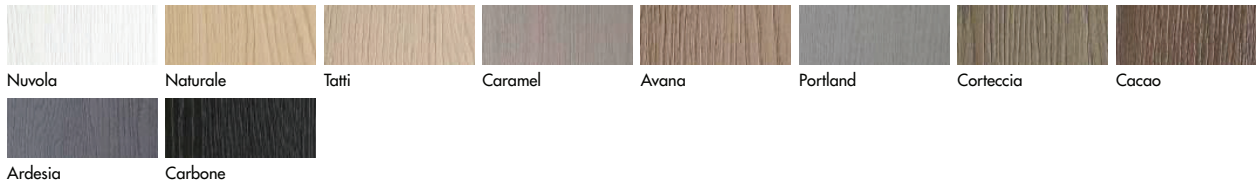

Nuvola

Naturale

Tatti

Caramel

Avana

Portland

Corteccia

Cacao

Ardesia

Carbone

ACCIAIO INOX

STAINLESS STEEL - ACIER INOX - ACERO INOX

*



Inox satinato

Inox vintage

* Prezzo su richiesta
 * Price upon request
 * Prix a la demande
 * Precio a petición

2 lati inox
 2 sides stainless steel
 2 cotes inox
 2 lados inox

solo per gola curva
 Only for curved groove
 uniquement pour gorge creuse
 Solamente para gola curva



Anta sp. 22 mm con maniglia "UP" orizzontale

Door th. 22 mm with horizontal "UP" handle
 Porte ép. 22 mm avec poignée "UP" horizontale
 Puerta esp. 22mm con tirador "UP" horizontal

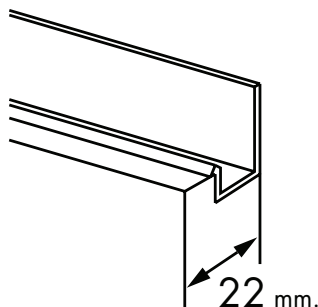

Ante pensile solo con bordo dritto
 Wall unit doors only available with straight edge
 Portes meuble haut seulement avec chant droit
 Puertas colgantes con canto recto

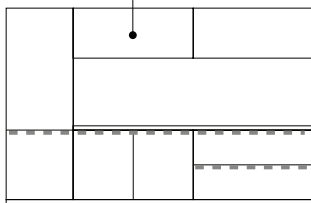

⚠ **Maggiorazione da applicare su ogni anta/cassetto/cestone**
 Extra charge for each door/drawer/deep drawer
 Supplement à rajouter à chaque porte/tiroir/coffre
 Sobrecosto para aplicar a cada puerta/cajon/gabeta

L. W./L./A.	UP €/cad
15 - 40	+ 35
41 - 55	+ 40
56 - 90	+ 45
91 - 150	+ 70



SENZA GOLA
 WITHOUT GROOVE
 SANS GORGE
 SIN GOLA

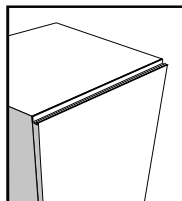

Finiture maniglia "UP":
 Finishes for "UP" handle:
 Finition poignée "UP":
 Colores Tirador "UP":



Esempio:
 E.g.: -Exemple: - Ejemplo:

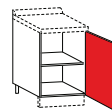

Maggiorazione:
 Upcharge:
 Supplement:
 Recargo:
€..... x 1



Maggiorazione:
 Upcharge:
 Supplement:
 Recargo:
€..... x 3

FINITURE

FINISHES - FINITIONS - ACABADOS

Fascia prezzo
 Price range
 Gamme de prix
 Grupo de precio

MELAMINICO TERMOSTRUTTURATO

MELAMINE THERMOFRAMED - MÉLAMINE THERMOSTRUCTURED - MELAMINICO TERMOESTRUCTURADO

Porro registro

Porro registro
 Porro registro
 Porro registro



Sabbaiato

Sabbaiato
 Sablé
 Sabbaiato



Materico

Textured
 Matériel
 Materico



Texture

Texture
 Texture
 Texture





MELAMINICO SUPERMATT
 SUPERMATT MELAMINE - MÉLAMINE SUPERMATT - MELAMINICO SUPERMATT

2

bianco laser	avorio	creta	shadow	grigio segnale	grigio ferro

2-3	TECNOLUX TECNOLUX - TECNOLUX - TECNOLUX				TECNOMATT TECNOMATT - TECNOMATT - TECNOMATT			
	2	3	3	3	2	3	3	3
	bianco	vaniglia	gianduia	fumo	bianco matt	office matt	gianduia matt	fumo matt

FENIX NTM
 FENIX NTM - FENIX NTM - FENIX NTM

4

bianco kos	grigio londra	nero ingo

FENIX NTM JTIME
 FENIX NTM JTIME - FENIX NTM JTIME - FENIX NTM JTIME

6

Bianco Malè	beige arizona	castoro ottawa	grigio efeso	grigio antrim	grigio bromo	verde comodore	piombo doha
titanio doha	bronzo doha						

FENIX NTA
 FENIX NTA - FENIX NTA - FENIX NTA

9

hamilton nta	oro cortez nta	argento dukat nta

LAMINATO HPL
 LAMINATE HPL - LAMINE HPL - LAMINADO HPL

5

Bianco Dax	grigio 104	canapa	gray 160	Nero Tecno	cemento portland	emperador	canova 434
Nocturne	porfido reale	ossido 146	brown 117				

LACCATI
 LACQUERED - LAQUES - LACADOS

4 sand / sand / Sand / sand

5 lucido / Glossy / Burlant / Brillo

6 soft-touch / soft-touch / Soft touch / soft-touch

9 ossidato / ossidato / ossidato / ossidato

10 metal / Metal / metal / metal

Tutte le finiture laccate sono consultabili nella sezione "K_Colors by Arrital" pag. 39
 All the lacquered finishes can be checked in the section "K_Colors by Arrital" at page 39
 Toutes les finitions laquées sont disponibles dans le chapitre "K_Colors by Arrital" pag. 39
 Todos los acabados pueden ser consultados en la seccion "K_Colors by Arrital" en la pagina 39

ROVERE SPAZZOLATO
 ROVERE SPAZZOLATO - CHENE BROSSE - ROVERE SPAZZOLATO

6

Nuvola	Naturale	Tatti	Caramel	Avana	Portland	Corteccia	Cacao
Ardesia	Carbone						



Ante sp. 22 mm con maniglia COVER-UP orizzontale.

Doors th.22 mm with horizontal COVER-UP handle
 porte ep.22mm avec poignée "COVER-UP" horizontale
 Puertas esp.22mm con tirador COVER -UP horizontal

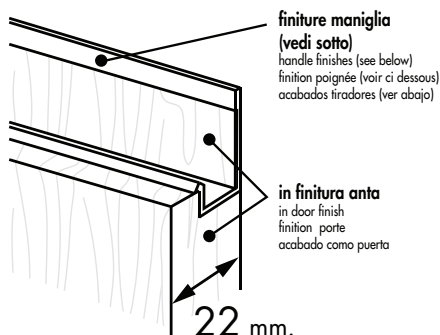

Ante pensile solo con bordo dritto

Wall unit doors only available with straight edge
 Portes meuble haut seulement avec chant droit
 Puertas colgantes con canto recto

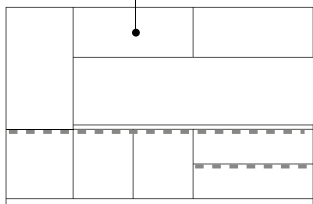

! **Maggiorazione da applicare su ogni ante/cassetto/cestone**
 Extra charge for each door/drawer/deep drawer
 Supplement à rajouter à chaque porte/tiroir/coffre
 Sobrecosto para aplicar a cada puerta/cajon/gabeta

L. W./L.A.	COVER UP €/cad
15 - 40	+ 40
41 - 55	+ 50
56 - 90	+ 70
91 - 150	+ 120



SENZA GOLA
 WITHOUT GROOVE
 SANS GORGE
 SIN GOLA

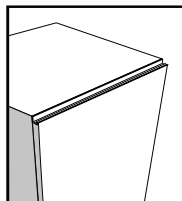

Finiture maniglia "COVER-UP":
 Finishes for "COVER-UP" handle:
 Finition poignée "COVER-UP":
 Colores Tirador "COVER UP" :



! **Inserto in finitura anta**
 Insert in door finish
 Insert en finition porte
 inserto en mismo acabado de la puerta

Esempio:

E.g.: -Exemple: - Ejemplo:

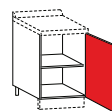

Maggiorazione:
 Upcharge:
 Supplement:
 Recargo:
€..... x 1



Maggiorazione:
 Upcharge:
 Supplement:
 Recargo:
€..... x 3

FINITURE

FINISHES - FINITIONS - ACABADOS

Fascia prezzo
 Price range
 Gamme de prix
 Grupo de precio

FENIX NTM

FENIX NTM - FENIX NTM - FENIX NTM

4



bianco kos



grigio londra



nero ingo

LACCATI

LACQUERED - LAQUES - LACADOS

4

sand / sand / Sand / sand

5

lucido / Glossy / Brillant / Brillo

6

soft-touch / soft-touch / Soft touch / soft-touch

9

ossidato / ossidato / ossidato / ossidato

10

metal / Metal / metal / metal

Tutte le finiture laccate sono consultabili nella sezione "K_Colors by Arrital" pag. 39
 All the lacquered finishes can be checked in the section "K_Colors by Arrital" at page 39
 Toutes les finitions laquées sont disponibles dans le chapitre "K_Colors by Arrital" pag. 39
 Todos los acabados pueden ser consultados en la sección "K_Colors by Arrital" en la pagina 39



ROVERE SPAZZOLATO

ROVERE SPAZZOLATO - CHENE BROSSE - ROVERE SPAZZOLATO

6



Nuvola



Naturale

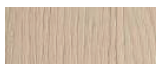

Tatti



Caramel

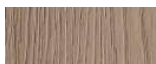

Avana



Portland

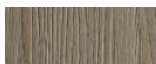

Corteccia



Cacao



Ardesia



Carbone



Ante sp. 22 mm con profilo "step" in alluminio e 3 lati bordo dritto, per mobili con gola curva o gola piatta.

22mm thick doors with aluminum "step" handle profile and 3 straight edges, for units with curved or flat
 Portes ép. 22 mm avec profil « step » en aluminium et 3 cotés chant droit, pour meubles avec gorge creuse ou gorge plate
 Puertas gr. 22 mm con perfil "step" en aluminio y 3 lados canto recto, para muebles con gola curva o gola plana

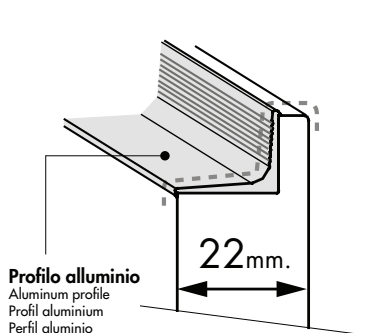

Ante pensile solo con bordo dritto
 Wall unit doors only available with straight edge
 Portes meuble haut seulement avec chant droit
 Puertas colgantes con canto recto

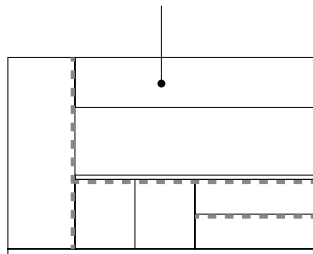

Finiture profilo:
 Profile finishes
 Finitions profil
 Acabados perfiles

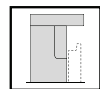

GOLA PIATTA
FLAT GROOVE
GORGE PLATE
GOLA PLANA

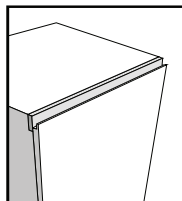

Finiture gola standard:
 Standard groove finishes
 Finitions gorge standard:
 Acabados gola estandard



Altre finiture disponibili:
 For more finishes:
 Autres finitions disponibles:
 Otros acabados disponibles:

Rivestite: Rovere spazzolato - Melaminico / Laccate: Sand - Lucido - Soft-touch - Metal - Ossidato
 Coated: Rovere spazzolato - Melaminico / Laccate: Sand - Lucido - Soft-touch - Metal - Ossidato
 Recouvert: Chêne brossé- mélaminé/ laqué sand - brillant - soft touch - Metal - Oxydé
 Forrado: Rovere spazzolato - Melaminico / Laccate: Sand - Lucido - Soft-touch - Metal - Ossidato

FINITURE

FINISHES - FINITIONS - ACABADOS

Fascia prezzo
 Price range
 Gamme de prix
 Grupo de precio

MELAMINICO TERMOSTRUTTURATO

MELAMINE THERMOFRAMED - MÉLAMINE THERMOSTRUCTURED - MELAMINICO TERMOESTRUCTURADO

Poro registro

Poro registro
 Poro registro
 Poro registro



Sabbiato

Sabbiato
 Sablé
 Sabbiato



Materico

Materico
 Textured
 Matériel
 Materico



Texture

Texture
 Texture
 Texture



2



MELAMINICO SUPERMATT
 SUPERMATT MELAMINE - MÉLAMINE SUPERMATT - MELAMINICO SUPERMATT

2

bianco laser	avorio	creta	shadow	grigio segnale	grigio ferro

2-3	TECNOLUX TECNOLUX - TECNOLUX - TECNOLUX				TECNOMATT TECNOMATT - TECNOMATT - TECNOMATT			
	2	3	3	3	2	3	3	3
	bianco	vaniglia	gianduia	fumo	bianco matt	office matt	gianduia matt	fumo matt

FENIX NTM
 FENIX NTM - FENIX NTM - FENIX NTM

4

bianco kos	grigio londra	nero ingo

FENIX NTM JTIME
 FENIX NTM JTIME - FENIX NTM JTIME - FENIX NTM JTIME

6

Bianco Malè	beige arizona	castoro ottawa	grigio efeso	grigio antrim	grigio bromo	verde comodore	piombo doha
titanio doha	bronzo doha						

FENIX NTA
 FENIX NTA - FENIX NTA - FENIX NTA

9

hamilton nta	oro cortez nta	argento dukat nta

LAMINATO HPL
 LAMINATE HPL - LAMINE HPL - LAMINADO HPL

5

Bianco Dax	grigio 104	canapa	gray 160	Nero Tecno	cemento portland	emperador	canova 434
Nocturne	porfido reale	ossido 146	brown 117				

LACCATI
 LACQUERED - LAQUES - LACADOS

4 sand / sand / Sand / sand

5 lucido / Glossy / Brillant / Brillo

6 soft-touch / soft-touch / Soft touch / soft-touch

9 ossidato / ossidato / ossidato / ossidato

10 metal / Metal / metal / metal

Tutte le finiture laccate sono consultabili nella sezione "K_Colors by Arrital" pag. 39
 All the lacquered finishes can be checked in the section "K_Colors by Arrital" at page 39
 Toutes les finitions laquées sont disponibles dans le chapitre "K_Colors by Arrital" pag. 39
 Todos los acabados pueden ser consultados en la seccion "K_Colors by Arrital" en la pagina 39

ROVERE SPAZZOLATO
 ROVERE SPAZZOLATO - CHENE BROSSE - ROVERE SPAZZOLATO

6

Nuvola	Naturale	Tatti	Caramel	Avana	Portland	Corteccia	Cacao
Ardesia	Carbone						

Ante sp. 22 mm con 1 lato bordo "30°" e 3 lati bordo dritto, per mobili con gola piatta

22mm thick doors with 30° profile and 3 straight edges, for units with flat groove
 Portes ép. 22 mm avec 1 coté chant « 30° » et 3 cotés chant droit, pour meubles avec gorge plate
 Puertas esp. 22 mm con 1 lado canto 30° y 3 lados cantos rectos para muebles con gola plana

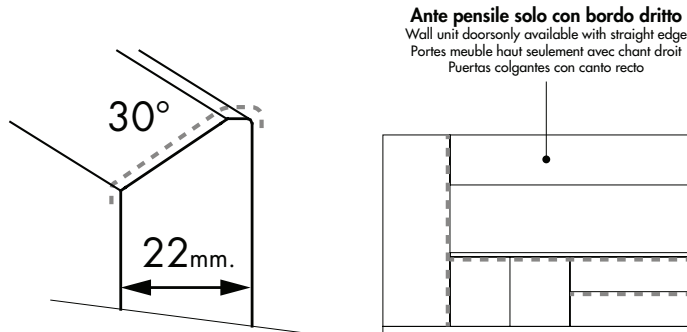

Ante pensile solo con bordo dritto
 Wall unit doors only available with straight edge
 Portes meuble haut seulement avec chant droit
 Puertas colgantes con canto recto



GOLA PIATTA
FLAT GROOVE
GORGE PLATE
GOLA PLANA

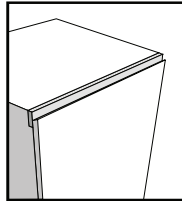

Finiture gola standard:
 Standard groove finishes
 Finitions gorge standard:
 Acabados gola estandard



Altre finiture disponibili:

For more finishes:
 Autres finitions disponibles:
 Otros acabados disponibles:

Rivestite: Rovere spazzolato - Melaminico / Laccate: Sand - Lucido - Soft-touch - Metal - Ossidato
 Coated: Rovere spazzolato - Melaminico / Laccate: Sand - Lucido - Soft-touch - Metal - Ossidato
 Recouvert: Chêne brossé - mélaminé / laqué sand - brillant - soft touch - Metal - Oxydé
 Forrado: Rovere spazzolato - Melaminico / Laccate: Sand - Lucido - Soft-touch - Metal - Ossidato

NOTE
NOTES:
NOTES:
NOTAS:

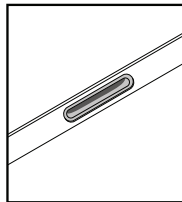

- Le ante per lavastoviglie a scomparsa e frigorifero sono dotate di una "presa-maniglia" in alluminio per aumentare la prensilità.
- Doors for fully-integrated dishwasher and refrigerator are provided with an integrated handle in aluminum to help the opening.
- Les portes pour lave-vaisselle à intégration totale et réfrigérateur sont pourvues d'une poignée intégrée en aluminium pour améliorer la préhension.
- Las puertas para lavavajillas y frigoríficos son abastecidas con una "barra de sujeción" en aluminio para aumentar el agarre.

FINITURE

FINISHES - FINITIONS - ACABADOS

Fascia prezzo
 Price range
 Gamme de prix
 Grupo de precio

LACCATI

LACQUERED - LAQUES - LACADOS

- | | |
|----|---------------------------------------------------|
| 4 | sand / sand / Sand / sand |
| 5 | lucido / Glossy / Brillant / Brillo |
| 6 | soft-touch / soft-touch / Soft touch / soft-touch |
| 9 | ossidato / ossidato / ossidato / ossidato |
| 10 | metal / Metal / metal / metal |

Tutte le finiture laccate sono consultabili nella sezione "K_Colors by Arrital" pag. 39
 All the lacquered finishes can be checked in the section "K_Colors by Arrital" at page 39
 Toutes les finitions laquées sont disponibles dans le chapitre "K_Colors by Arrital" pag. 39
 Todos los acabados pueden ser consultados en la sección "K_Colors by Arrital" en la página 39



ROVERE SPAZZOLATO

ROVERE SPAZZOLATO - CHENE BROSSE - ROVERE SPAZZOLATO

6



Nuvola



Naturale

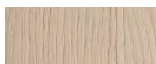

Tatti



Caramel

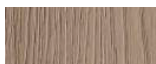

Avana



Portland

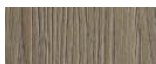

Corteccia



Cacao



Ardesia



Carbone



Ante sp. 22 mm con 1 lato profilo "30°" in alluminio e 3 lati bordo dritto, per mobili con gola piatta.

22mm thick doors with 30° aluminum profile and 3 straight edges, for units with flat groove profile
 Portes ép. 22 mm avec 1 coté profil « 30° » en aluminium et 3 cotes chant droit, pour meubles avec gorge plate
 Puertas esp.22 con 1 lado con perfil 30° en aluminio y 3 cantos rectos, para muebles con gola plana

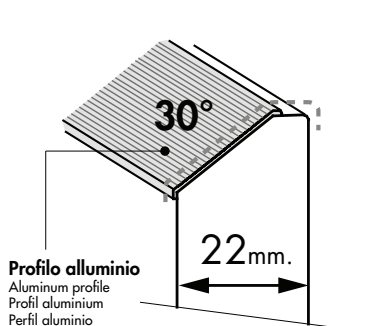

Ante pensile solo con bordo dritto
 Wall unit doors only available with straight edge
 Portes meuble haut seulement avec chant droit
 Puertas colgantes con canto recto

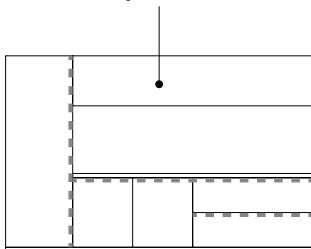

Finiture profilo:
 Profile finishes
 Finitions profil
 Acabados perfiles

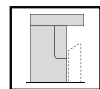
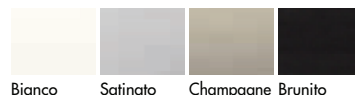

GOLA PIATTA
FLAT GROOVE
GORGE PLATE
GOLA PLANA

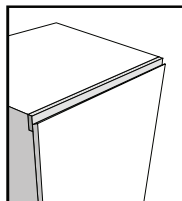

Finiture gola standard:
 Standard groove finishes
 Finitions gorge standard:
 Acabados gola estandard



Altre finiture disponibili:
 For more finishes:
 Autres finitions disponibles:
 Otros acabados disponibles:

Rivestite: Rovere spazzolato - Melaminico / Laccate: Sand - Lucido - Soft-touch - Metal - Ossidato
 Coated: Rovere spazzolato - Melaminico / Laccate: Sand - Lucido - Soft-touch - Metal - Ossidato
 Recouvert: Chêne brossé- melaminé/ laqué sand - brillant - soft touch - Metal - Oxydé
 Forrado: Rovere spazzolato - Melaminico / Laccate: Sand - Lucido - Soft-touch - Metal - Ossidato

FINITURE

FINISHES - FINITIONS - ACABADOS

Fascia prezzo
 Price range
 Gamme de prix
 Grupo de precio

MELAMINICO TERMOSTRUTTURATO

MELAMINE THERMOFRAMED - MÉLAMINE THERMOSTRUCTURED - MELAMINICO TERMOESTRUCTURADO

Poro registro

Poro registro
 Poro registro
 Poro registro



Sabbiato

Sabbiato
 Sablé
 Sabbiato



Materico

Materico
 Textured
 Matériel
 Materico



Texture

Texture
 Texture
 Texture



2



MELAMINICO SUPERMATT

SUPERMATT MELAMINE - MÉLAMINE SUPERMATT - MELAMINICO SUPERMATT

2

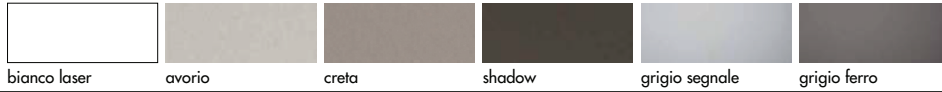

bianco laser avorio creta shadow grigio segnale grigio ferro

TECNOLUX

TECNOLUX - TECNOLUX - TECNOLUX

TECNOMATT

TECNOMATT - TECNOMATT - TECNOMATT

2-3



bianco vaniglia gianduia fumo bianco matt office matt gianduia matt fumo matt

FENIX NTM

FENIX NTM - FENIX NTM - FENIX NTM

4



bianco kos grigio Londra nero ingo

FENIX NTM JTIME

FENIX NTM JTIME - FENIX NTM JTIME - FENIX NTM JTIME

6



Bianco Malè beige arizona castoro ottawa grigio efeso grigio antrim grigio bromo verde comodore piombo doha titanio doha bronzo doha

FENIX NTA

FENIX NTA - FENIX NTA - FENIX NTA

9



hamilton nta oro cortez nta argento dukat nta

LAMINATO HPL

LAMINATE HPL - LAMINE HPL - LAMINADO HPL

5

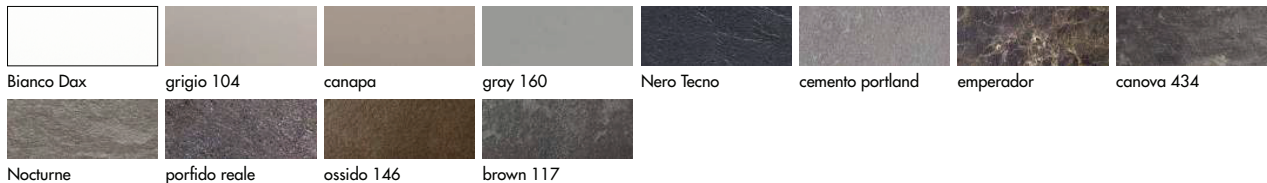

Bianco Dax grigio 104 canapa gray 160 Nero Tecno cemento portland emperador canova 434 Nocturne porfido reale ossido 146 brown 117

LACCATI

LACQUERED - LAQUES - LACADOS

4

sand / sand / Sand / sand

5

lucido / Glossy / Brillant / Brillo

6

soft-touch / soft-touch / Soft touch / soft-touch

9

ossidato / oxidato / oxidato / oxidato

10

metal / Metal / metal / metal

Tutte le finiture laccate sono consultabili nella sezione "K_Colors by Arrital" pag. 39
 All the lacquered finishes can be checked in the section "K_Colors by Arrital" at page 39
 Toutes les finitions laquées sont disponibles dans le chapitre "K_Colors by Arrital" pag. 39
 Todos los acabados pueden ser consultados en la seccion "K_Colors by Arrital" en la pagina 39

ROVERE SPAZZOLATO

ROVERE SPAZZOLATO - CHENE BROSSE - ROVERE SPAZZOLATO

6

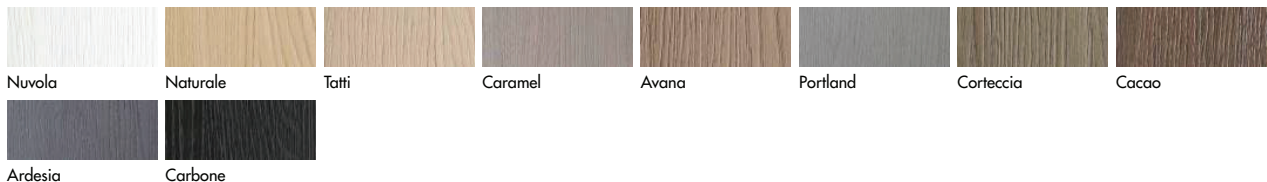

Nuvola Naturale Tatti Caramel Avana Portland Corteccia Cacao Ardesia Carbone



Ante sp. 22 mm con maniglia incasso per mobili con gola piatta.

Doors th.22 mm with recessed handle for units with flat groove
 Porte ép.22 mm avec poignée encastrée pour meubles avec gorge plate
 Puerta esp.22mm con tirador empotrado para bajos con gola

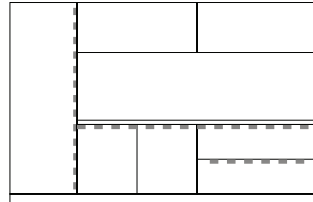
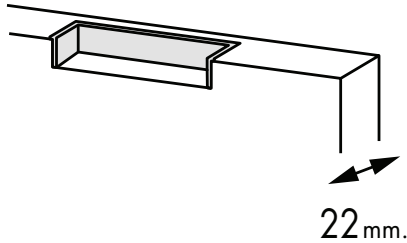

Finiture maniglia incasso:
 Finishes for recessed handles:
 Finition poignée encastrée
 Colores tirador empotrado :

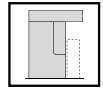

GOLA PIATTA
FLAT GROOVE
GORGE PLATE
GOLA PLANA

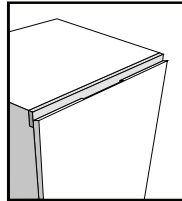

Finiture gola standard:
 Standard groove finishes
 Finitions gorge standard:
 Acabados gola estandard



Altre finiture disponibili:
 For more finishes:
 Autres finitions disponibles:
 Otros acabados disponibles:

Rivestite: Rovere fiammato - termocotto / **Laccate:** Sand - Lucido - Soft-touch - Metal - Ossidato
Coated: Rovere fiammato - termocotto / **Laccate:** Sand - Lucido - Soft-touch - Metal - Ossidato
Recouvert: Chêne flammé - termocotto / **laqué:** sand - brillant - soft touch - Metal - Oxydé
Fornado: Rovere fiammato - termocotto / **Laccate:** Sand - Lucido - Soft-touch - Metal - Ossidato

FINITURE

FINISHES - FINITIONS - ACABADOS

Fascia prezzo
 Price range
 Gamme de prix
 Grupo de precio

MELAMINICO TERMOSTRUTTURATO

MELAMINE THERMOFRAMED - MÉLAMINE THERMOSTRUCTURED - MELAMINICO TERMOESTRUCTURADO

Poro registro

Poro registro
 Poro registro
 Poro registro



Sabbiato

Sabbiato
 Sablé
 Sabbiato



Materico

Textured
 Matériel
 Materico



Texture

Texture
 Texture
 Texture



2



MELAMINICO SUPERMATT
 SUPERMATT MELAMINE - MÉLAMINE SUPERMATT - MELAMINICO SUPERMATT

2

bianco laser	avorio	creta	shadow	grigio segnale	grigio ferro

TECNOLUX
 TECNOLUX - TECNOLUX - TECNOLUX

2-3

bianco	vaniglia	gianduia	fumo

TECNOMATT
 TECNOMATT - TECNOMATT - TECNOMATT

bianco matt	office matt	gianduia matt	fumo matt

FENIX NTM
 FENIX NTM - FENIX NTM - FENIX NTM

4

bianco kos	grigio Londra	nero ingo

FENIX NTM JTIME
 FENIX NTM JTIME - FENIX NTM JTIME - FENIX NTM JTIME

6

Bianco Malè	beige arizona	castoro ottawa	grigio efeso	grigio antrim	grigio bromo	verde comodore	piombo doha
titanio doha	bronzo doha						

FENIX NTA
 FENIX NTA - FENIX NTA - FENIX NTA

9

acciaio hamilton	acciaio oro cortez	acciaio argento dukat

LAMINATO HPL
 LAMINATE HPL - LAMINE HPL - LAMINADO HPL

5

Bianco Dax	grigio 104	canapa	gray 160	Nero Tecno	cemento portland	emperador	canova 434
Nocturne	porfido reale	ossido 146	brown 117				

LACCATI
 LACQUERED - LAQUES - LACADOS

4 sand / sand / Sand / sand

5 lucido / Glossy / Brillant / Brillo

6 soft-touch / soft-touch / Soft touch / soft-touch

9 ossidato / ossidato / ossidato / ossidato

10 metal / Metal / metal / metal

Tutte le finiture laccate sono consultabili nella sezione "K_Colors by Arrital" pag. 39
 All the lacquered finishes can be checked in the section "K_Colors by Arrital" at page 39
 Toutes les finitions laquées sont disponibles dans le chapitre "K_Colors by Arrital" pag. 39
 Todos los acabados pueden ser consultados en la seccion "K_Colors by Arrital" en la pagina 39

ROVERE SPAZZOLATO
 ROVERE SPAZZOLATO - CHENE BROSSE - ROVERE SPAZZOLATO

6

Nuvola	Naturale	Tatti	Caramel	Avana	Portland	Corteccia	Cacao
Ardesia	Carbone						